

ViewSonic®



VSD241
Smart Display
User Guide

Model No. VS15197

Compliance Information

Please read before proceeding

- Use only the batteries and power adapter provided by the manufacturer. The use of unauthorized accessories may void your warranty.
- Do not store your device in temperatures higher than 50°C (122°F).
- The operating temperature for this device is from 0°C (32°F) to 35°C (95°F).

FCC Notice

The following statement applies to all products that have received FCC approval. Applicable products bear the FCC logo, and/or an FCC ID in the format FCC ID: GSS-VS15197 on the product label. This device complies with part 15 of the FCC Rules. Operation is subject to the following two conditions: (1) This device may not cause harmful interference, and (2) This device must accept any interference received, including interference that may cause undesired operation. This mobile device has been tested and found to comply with the limits for a Class B digital device, pursuant to Part 15 of the FCC Rules. These limits are designed to provide reasonable protection against harmful interference in a residential installation. This equipment generates, uses and can radiate radio frequency energy and, if not installed and used in accordance with the instructions, may cause harmful interference to radio communications. However, there is no guarantee that interference will not occur in a particular installation. If this equipment does cause harmful interference to radio or television reception, which can be determined by turning the equipment off and on, the user is encouraged to try to correct the interference by one or more of the following measures

- Reorient or relocate the receiving antenna.
- Increase the separation between the equipment and receiver.
- Connect the equipment into an outlet on a circuit different from that to which the receiver is connected.
- Consult the dealer or an experienced radio/TV technician for help.

Changes or modifications not expressly approved by the party responsible for compliance could void the user's authority to operate the equipment. The antenna(s) used for this transmitter must not be colocated or operating in conjunction with any other antenna or transmitter.

The device was tested and complies to measurement standards and procedures specified in FCC OET Bulletin 65, Supplement C

FCC SAR Information

This equipment complies with FCC radiation exposure limits set forth for an uncontrolled environment. End users must follow the specific operating instructions for satisfying RF exposure compliance.

This transmitter must not be co-located or operating in conjunction with any other antenna or transmitter. This equipment should be installed and operated with a minimum distance of 20 centimeters between the radiator and your body.

The user's manual or instruction manual for an intentional or unintentional radiator shall caution the user that changes or modifications not expressly approved by the party responsible for compliance could void the user's authority to operate the equipment.

Canada Statement

This device complies with Industry Canada licence-exempt RSS standard(s). Operation is subject to the following two conditions: (1) this device may not cause interference, and (2) this device must accept any interference, including interference that may cause undesired operation of the device.

Caution: Exposure to Radio Frequency Radiation

To comply with RSS 102 RF exposure compliance requirements, a separation distance of at least 20 cm must be maintained between the antenna of this device and all persons.

Pour se conformer aux exigences de conformité CNR 102 RF exposition, une distance de séparation d'au moins 20 cm doit être maintenue entre l'antenne de cet appareil et toutes les personnes.

CE Conformity for European Countries

 The device complies with the EMC Directive 2004/108/EC and Low Voltage Directive 2006/95/EC, R&TTE Directive 1999/5/EC.

Following information is only for EU-member states:

The mark shown to the right is in compliance with the Waste Electrical and Electronic Equipment Directive 2002/96/EC (WEEE).

The mark indicates the requirement NOT to dispose the equipment as unsorted municipal waste, but use the return and collection systems according to local law.

If the batteries, accumulators and button cells included with this equipment, display the chemical symbol Hg, Cd, or Pb, then it means that the battery has a heavy metal content of more than 0.0005% Mercury, or more than 0.002% Cadmium, or more than 0.004% Lead.



European Union Regulatory Conformance

The equipment complies with the RF Exposure Requirement 1999/519/EC, Council Recommendation of 12 July 1999 on the limitation of exposure of the general public to electromagnetic fields (0-300 GHz). This equipment meets the following conformance standards: EN301489-1, EN301489-17, EN55022/24, EN60950-1, EN300328.

We, hereby, declare that this Wi-Fi & Bluetooth radio is in compliance with the essential requirements and other relevant provisions of Directive 1999/5/EC.

ENERGY STAR

This ENERGY STAR qualified product saves your money by reducing energy cost and protecting the environment without sacrificing features or performance. We are proud to offer our customers products with the ENERGY STAR mark.

What is ENERGY STAR?

Products that are ENERGY STAR qualified use less energy and prevent greenhouse gas emissions by meeting strict energy efficiency guidelines set by the U.S. Environmental Protection Agency. We commit to offering products and services worldwide that help customers save money, conserve energy and improve the quality of our environment. The more energy we can save through higher energy efficiency, the more we reduce greenhouse gases and the risks of climate change. More information refers to **www.energystar.gov** or **ww.energystar.gov/powermanagement**.

Note: Information in this section may not apply to your computer.

This ENERGY STAR qualified product:

- produces less heat and reduce cooling loads in warmer climates.
- automatically goes into "display Sleep" and "computer Sleep" mode after 10 minutes of inactivity.
- wakes from "Sleep" mode by pressing the power button.
- saves more than 80% energy when in "Sleep" mode.

ENERGY STAR and the ENERGY STAR mark are registered U.S. marks.



Declaration of RoHS2 Compliance

This product has been designed and manufactured in compliance with Directive 2011/65/EU of the European Parliament and the Council on restriction of the use of certain hazardous substances in electrical and electronic equipment (RoHS2 Directive) and is deemed to comply with the maximum concentration values issued by the European Technical Adaptation Committee (TAC) as shown below:

Substance	Proposed Maximum Concentration	Actual Concentration
Lead (Pb)	0.1%	< 0.1%
Mercury (Hg)	0.1%	< 0.1%
Cadmium (Cd)	0.01%	< 0.01%
Hexavalent Chromium (Cr6+)	0.1%	< 0.1%
Polybrominated biphenyls (PBB)	0.1%	< 0.1%
Polybrominated diphenyl ethers (PBDE)	0.1%	< 0.1%

Certain components of products as stated above are exempted under the Annex III of the RoHS2 Directives as noted below:

Examples of exempted components are:

1. Mercury in cold cathode fluorescent lamps and external electrode fluorescent lamps (CCFL and EEFL) for special purposes not exceeding (per lamp):
 - (1) Short length (≤ 500 mm): maximum 3.5 mg per lamp.
 - (2) Medium length (> 500 mm and $\leq 1,500$ mm): maximum 5 mg per lamp.
 - (3) Long length ($> 1,500$ mm): maximum 13 mg per lamp.
2. Lead in glass of cathode ray tubes.
3. Lead in glass of fluorescent tubes not exceeding 0.2% by weight.
4. Lead as an alloying element in aluminium containing up to 0.4% lead by weight.
5. Copper alloy containing up to 4% lead by weight.
6. Lead in high melting temperature type solders (i.e. lead-based alloys containing 85% by weight or more lead).
7. Electrical and electronic components containing lead in a glass or ceramic other than dielectric ceramic in capacitors, e.g. piezoelectronic devices, or in a glass or ceramic matrix compound.

Important Safety Instructions

1. DO NOT place objects on top of the device, as objects may scratch the screen.
2. DO NOT expose the device to dirty or dusty environments.
3. DO NOT place the device on an uneven or unstable surface.
4. DO NOT insert any foreign objects into the device.
5. DO NOT expose the device to strong magnetic or electrical field.
6. DO NOT expose the device to direct sunlight as it can damage the LCD Screen. Keep it away from heat sources.
7. DO NOT use the device in the rain.
8. Please check with your Local Authority or retailer for proper disposal of electronic products.
9. The device and the adapter may produce some heat during normal operation or charging. To prevent discomfort or injury from heat exposure, DO NOT leave the device on your lap.
10. POWER INPUT RATING: Refer to the rating label on the device and be sure that the power adapter complies with the rating. Only use accessories specified by the manufacturer.
11. DO NOT use a pen or any sharp object to tap the screen.
12. Clean the touch screen with a soft cloth. If needed, dampen the cloth slightly before cleaning. Never use abrasives or cleaning solutions.
13. Always power off the device to install or remove external devices that do not support hot-plug.
14. Disconnect the device from an electrical outlet and power off before cleaning the device.
15. DO NOT disassemble the device. Only a certified service technician should perform repair.
16. The device has apertures to disperse heat. DO NOT block the device ventilation, the device may become hot and malfunction as a result.
17. Users have to use the connection to USB interfaces with USB 2.0 version or higher.
18. PLUGGABLE EQUIPMENT: the socket-outlet shall be installed near the equipment and shall be easily accessible.

Copyright Information

Copyright © ViewSonic® Corporation, 2013. All rights reserved.

Android™ is a trademark of Google Inc. Use of this trademark is subject to Google Permissions.

This product has an Android™ platform based on Linux, which can be expanded by a variety of JME-based application SW.

All products used in this device and trademarks mentioned herein are trademarks or registered trademarks of their respective owners.

Google™, the Google logo, Android™, the Android logo and Gmail™ are trademarks of Google Inc. Use of this trademark is subject to Google Permissions.

Wi-Fi and the Wi-Fi CERTIFIED logo are registered trademarks of the Wireless Fidelity Alliance.

microSD™ is a trademark of SD Card Association.

Bluetooth and the Bluetooth logo are trademarks owned by Bluetooth SIG, Inc. Java, JME and all other Java-based marks are trademarks or registered trademarks of Sun Microsystems, Inc. in the United States and other countries.

The actual included applications (apps) may differ from the illustrated screen shots.

VESA® is a registered trademark of the Video Electronics Standards Association. DPMS and DDC are trademarks of VESA®.

ENERGY STAR® is a registered trademark of the U.S. Environmental Protection Agency (EPA).

As an ENERGY STAR® partner, ViewSonic Corporation has determined that this product meets the ENERGY STAR® guidelines for energy efficiency.

Disclaimer: ViewSonic Corporation shall not be liable for technical or editorial errors or omissions contained herein; nor for incidental or consequential damages resulting from furnishing this material, or the performance or use of this product. In the interest of continuing product improvement, ViewSonic Corporation reserves the right to change product specifications without notice. Information in this document may change without notice.

No part of this document may be copied, reproduced, or transmitted by any means, for any purpose without prior written permission from ViewSonic Corporation.

Intellectual Property Right Information

Right to all technologies and products that comprise this device are the property of their respective owners:

This product has an Android platform based on Linux, which can be expanded by a variety of Java-Script-based application SW.

Google, the Google logo, Android, the Android logo, Gmail, and YouTube are trademarks of Google Inc. Bluetooth and the Bluetooth logo are trademarks owned by Bluetooth SIG, Inc. Java, JME and all other Java-based marks are trademarks or registered trademarks of Sun Microsystems, Inc. in the United States and other countries. microSD is a trademark of SD Card Association.

Product Registration

To meet your future needs, and to receive any additional product information as it becomes available, please register your product on the Internet at: www.viewsonic.com.

For Your Records	
Product Name:	VSD241 ViewSonic Smart Display
Model Number:	VS15197
Document Number:	VSD241_UG_ENG Rev. 1C 10-16-13
Serial Number:	_____
Purchase Date:	_____

Product disposal at end of product life

ViewSonic respects the environment and is committed to working and living green. Thank you for being part of Smarter, Greener Computing. Please visit ViewSonic website to learn more.

USA & Canada: <http://www.viewsonic.com/company/green/recycle-program/>

Europe: <http://www.viewsoniceurope.com/uk/support/recycling-information/>

Taiwan: <http://recycle.epa.gov.tw/recycle/index2.aspx>

Table of Contents

1 VSD241 Smart Display Features

- 1.1 Installing wall mount bracket 4

2 Set Up Your VSD241 Smart Display

- 2.1 Connection 5
- 2.2 Get Your Smart Display Ready for Use 5
- 2.3 Power on Your Device 6
 - 2.3.1 Wake on LAN (WOL) Function 7
- 2.4 Power Off Your Device 7

3 About Your VSD241 Smart Display

- 3.1 Touch Screen 8
- 3.2 Applications, Widgets and Shortcuts 9
- 3.3 Home Screen 9
- 3.4 Navigation buttons 11
- 3.5 Status Bar 11
 - 3.5.1 Managing Status Menu 12
- 3.6 Customizing Your Home Screen 12
 - 3.6.1 Add an Item (Shortcut) 12
 - 3.6.2 Move an Item 13
 - 3.6.3 Delete an Item 13
 - 3.6.4 Change the Wallpaper 13
- 3.7 Navigating the Applications 14
 - 3.7.1 Apps screen 14
 - 3.7.2 Application Shortcuts 14
 - 3.7.3 Recent Applications 15
 - 3.7.4 Screen Lock Wallpaper 15

4 Using Your VSD241 Smart Display

- 4.1 Managing Contacts 16
 - 4.1.1 Add a new contact 16
 - 4.1.2 Find a contact 17
 - 4.1.3 E-mail or send a message to a contact 17
- 4.2 Pop-up Menu 19
- 4.3 Google Search 20

4.4	Managing Your Device Settings	21
4.4.1	Check storage spaces	21
4.4.2	Remove the SD card safely	22
4.4.3	Erase all data from your device	22
4.5	Connecting to HDMI-compliant Devices via HDMI Input..	23
4.6	Bluetooth Connection	24
4.6.1	Turn on Bluetooth and make the device discoverable	24
4.6.2	Pair with a Bluetooth device	24
4.6.3	Terminate a pairing partnership	25
4.6.4	Change your device's Bluetooth name	25

5 Internet

5.1	Connecting to the Internet	26
5.1.1	Wi-Fi connection	26
5.1.2	Check the current Wi-Fi network connection	27
5.1.3	Connect to another Wi-Fi network	27
5.2	Synchronizing Your Google Data	28
5.3	Video Chat	28

6 Customizing Your VSD241 Smart Display

6.1	Display Settings	30
6.2	Sound and Ringtone Settings	31
6.2.1	System settings	31
6.2.2	Notifications settings	31
6.2.3	ViewSound enhancement	32
6.3	Date, Time, and Time Zone	32
6.4	Language & Input Settings	33
6.5	OSD Menu	34
6.5.1	Adjustment Bars	35
6.5.2	Functions items	35
6.5.3	OSD Notice	36

7 Protecting Your VSD241 Smart Display

7.1	Protect Your Device Data with a Screen Unlock Pattern..	37
7.1.1	Create a screen unlock pattern	38
7.1.2	Change unlock pattern settings	38
7.2	Disable the screen unlock security	39
7.3	Protect Your Device Data with a PIN	39
7.3.1	Disable or change PIN	39

Table of Contents

7.4	Protect Your Device Data with a Password	40
7.4.1	Disable or change the password	40
7.5	Protect Your Device Data with Face Unlock	41
7.6	Power Saving Feature	42
7.7	Power Management Information	42

8 Troubleshooting

8.1	Touch Screen Problems	43
8.2	Messaging Problems	43
8.3	Other Problems	44

9 Appendix

	Specification	45
--	---------------------	----

VSD241 is a Smart Display with 24-inch quad-core display running on Android 4.2.1 Jelly Bean. Comes with 1920x1080p HD multi-touch resolution, allow you to work with HDMI via MHL, full-sized USB, Bluetooth connectivity as well.

1 VSD241 Smart Display Features

This section introduces you to the features of your Smart Display.

NOTE

- The features or applications described in this User’s manual may vary depended on the device model purchased.

Front View

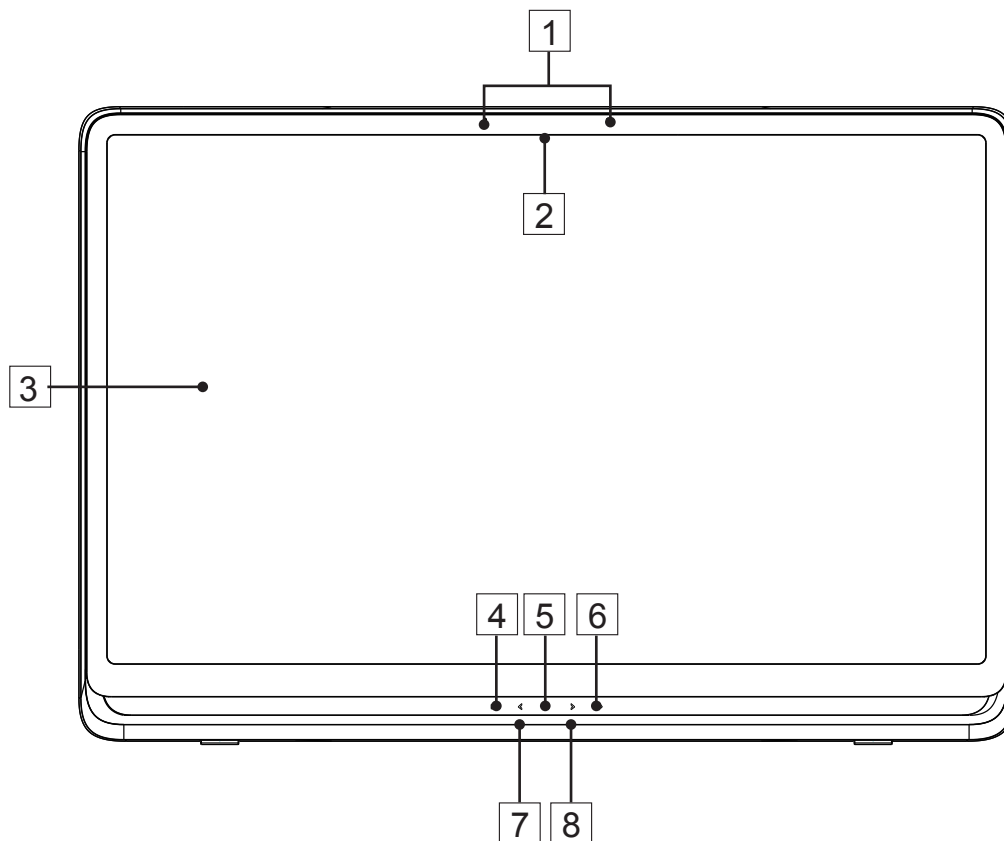

No.	Components	Descriptions
1	Microphone	Used for receiving audio or audio input.
2	Front-Panel Camera	- Used for taking a front picture just the same as a self-portrait. - Used for making video calls with supportive web applications, such as Google talk.

VSD241 Smart Display Features

No.	Components	Descriptions
3	Touch Screen	Touch the screen to control the on-screen configurations including menu items, applications, buttons, keyboard and so on.
4	OSD Menu / Exit	Touch this button to launch the OSD configuration menu and touch again to exit.
5	Power button (LED indicator)	<p>Touch to power on / lock the smart display.</p> <ul style="list-style-type: none"> - Touch about 0.5 seconds to power on the power (LED in blue) - Lock the smart display when the display is on (LED turns into orange). - Recall the unlock display when the smart display is locked. - When the display is on, press this button and hold for about 3 seconds to shut down the smart display (under Android mode).
6	Input Signal Switch / OSD Menu Select	<ul style="list-style-type: none"> - Touch to switch input signal (HDMI / Android). - Select function in OSD menu.
7	Arrow Button (Down / Left)	Use the arrow buttons (Down / Left and Up / Right) to move through OSD menus. You can highlight a menu item by touching the arrow buttons. You can also use the arrow buttons to adjust the values to each item of OSD menu.
8	Arrow Button (Up / Right)	

Back View

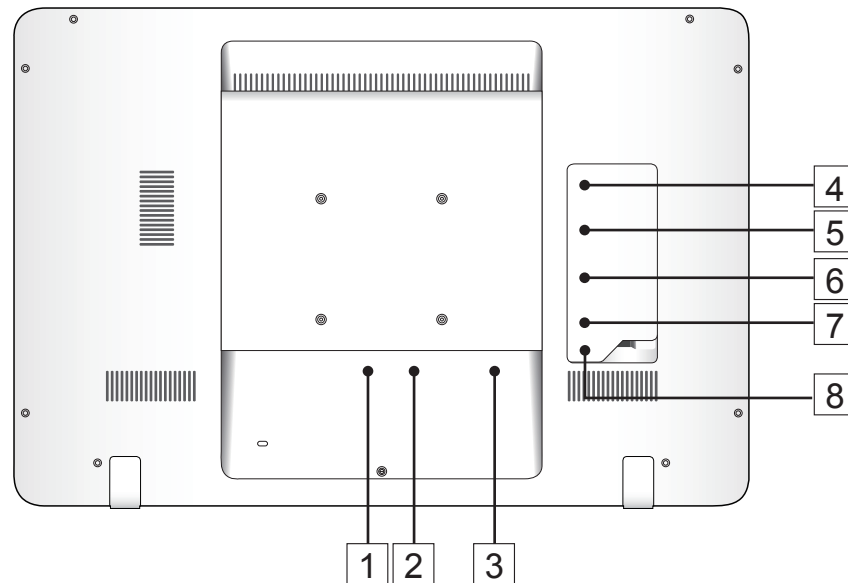

No.	Components	Descriptions
1	DC in Port	Connect to power adaptor.
2	HDMI	Connect to digital high quality device for video and audio configurations (e.g. DVD Player, BD Player VPG or Notebook).
3	RJ45 Connector	Connect to a RJ45 cable for network connection.
4	USB Ports x 2	Used for keyboard, mouse, flash disk (supports FAT32 format only) or printer connections.
5	Mini USB Port	External display mode for USB upstream, Webcam and Touch-screen control functionality.
6	Micro USB Port	Connect to windows computer for data transferring. (Need MTP driver)
7	SD Card Slot	Input SD card to extend storage capacity.
8	Earphone Jack	Connect to earphone or headset.

1.1 Installing wall mount bracket

The VSD241 supports wall mount bracket installation. We recommend using mounting interface that comply with Video Electronics Standards Association (VESA) standard. Please follow the steps to install your bracket:

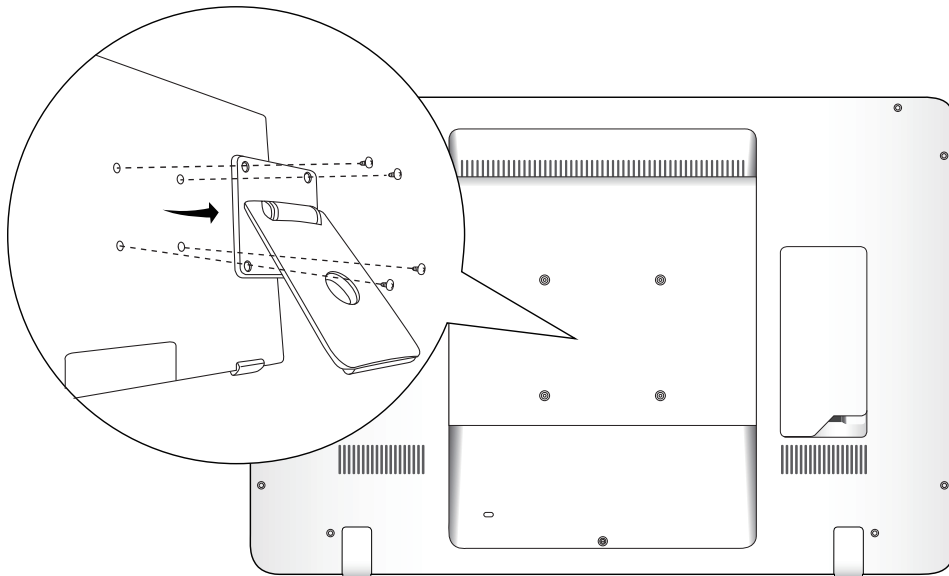

-
- 1** Turn off your monitor and unplug its power cord.

 - 2** Lay the monitor face-down on a flat surface. Take care to protect the screen.

 - 3** Remove the screws for wall mount and then remove the cover plate.

 - 4** Align the wall mount bracket with the holes which are compliant with VESA standard mounting hole pattern 100mmx100mm in the mounting pad and secure it with the four screws supplied with the arm-type base, wall mount hanger or other base.
-

2 Set Up Your VSD241 Smart Display

2.1 Connection

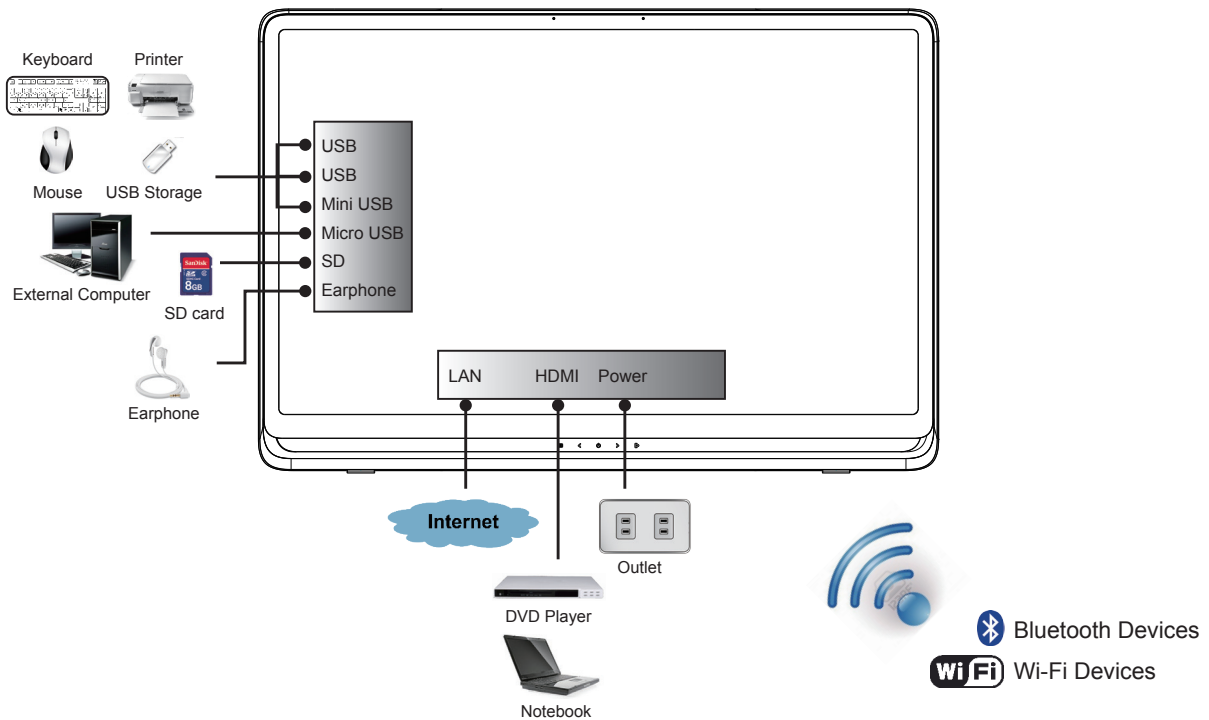

2.2 Get Your Smart Display Ready for Use

Insert the SD card

- 1 Open the compartment cover on the back of the smart display.

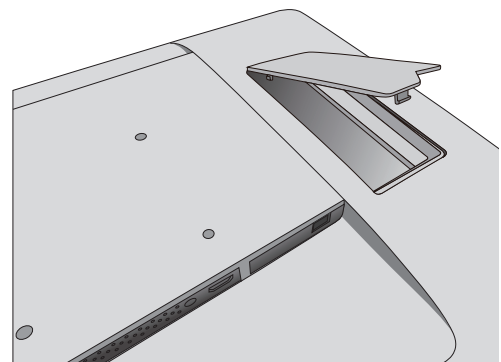

- 2 Insert a SD card if desired and / or available on the back of your smart display.

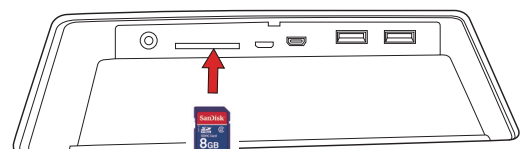

Connect the Power Cord

1 Connect the included power cord to the power jack.

2 Connect the other end of the power cord to a suitable power outlet.

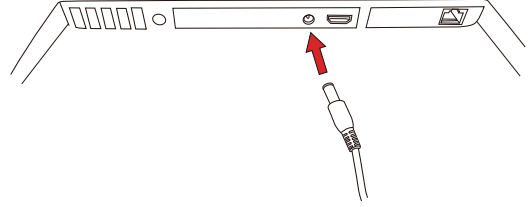

2.3 Power on Your Device

Touch the power button gently to power on your device

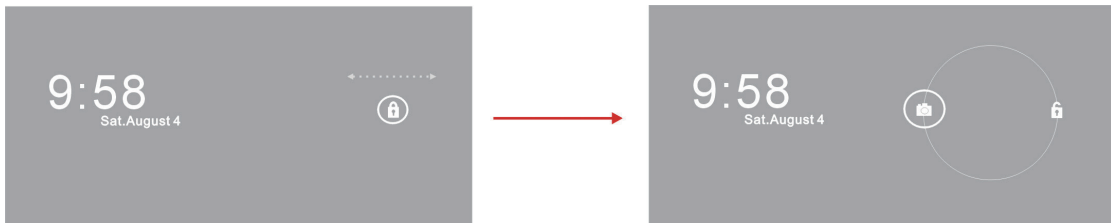

Slide the lock icon to unlock the screen
(if the lock screen function with slide is enabled)

1 After connecting the power cord, you can touch the power button about 0.5 seconds on the bottom of front panel to power on your device.

2 Once powered-up, the LED indicator will show solid Blue.

3 The unlock display will appear after a short boot-up period. (If the lock screen function is enabled).

4 Touch and slide the lock icon to unlock the screen if necessary.

5 The device is ready for use when the Home screen is displayed.

2.3.1 Wake on LAN (WOL) Function

To Enable the Wake on LAN (WOL) Function:

- Touch **Settings** icon on the screen.
- Check **Ethernet** is **ON**.
- Choose **More...** under **Data usage** row.
- Enable **Wakeup on Lan** on the right-hand side of screen.

2.4 Power Off Your Device

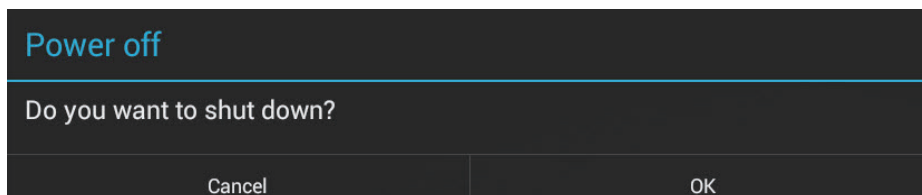

1 Touch and hold the power button for about 3 seconds.

2 When the power off menu appears, touch **OK**.

3 About Your VSD241 Smart Display

3.1 Touch Screen

The main way to control the device is using your finger to touch the sensitive surface of the screen directly. You can manipulate icons, buttons, menu items, on-screen keyboard and other items on the touch screen with below methods:

Methods	Descriptions
Touch	Simply touch the items with you finger. - Act on items on the screen including application and settings icons. - Type letters and symbols using the on-screen keyboard. - Press the on-screen buttons.
Touch and Hold	Touch and hold an item on the screen by touching it without lifting your finger until an action occurs.
Drag	Touch and hold an item then move the item with your finger until reaching the target position. - Move an item on the screen. - Scroll through Home screens, web pages, lists, entries, photo thumbnails, contacts and so on.
Swipe or Slide	Quickly move your finger across the surface of the screen without pausing when you first touch it.
Zoom Out	Move two fingers close together on the screen to reduce the view of an image or web page.
Zoom In	Move two fingers apart on the screen to enlarge the view of an image or web page.

NOTE

- You can connect the dots three to zoom the entire display frequency, also with two fingers to rotate and zoom the display for ex. Google map, as well as voice output designed specifically for blind users and gesture mode navigation features.

3.2 Applications, Widgets and Shortcuts

The soft buttons or icons offer a variety of functions and shortcuts. On the Home screen, it is your starting point to access all the features on your device. It displays application icons, widgets, shortcuts and so on.

Applications: Software allows you to perform a specific task. Power on your device, it is preloaded with a variety of applications already. You can also download additional applications from the Google Play Store.

Widgets: Widgets are applications that you can use directly on the Home screen. Example: Analog clock, Bookmark, Picture frame, the Google search bar and so on.









Shortcuts: A link that you can create on your Home screen to provide quicker access to applications you have installed.

3.3 Home Screen

Once you power on your device, and unlock your screen, the central Home screen will display firstly. You can also touch the  Home button to go to Home screen. On the Home screen, it allows you to access all the features installed in your device.

The Home screen is composed of five screen panels. You can slide your finger to left or right across the central Home screen to view more widgets, shortcuts, and other items located on each screen panel. You can also add shortcuts, widgets or change the desktop wallpaper on each screen panel.







No.		Items	Descriptions
1	Google	Google Search	Use the Google Search application to search the web faster and easier from Google.
2		Navigation Area	Flick and drag the screen horizontally until the desired Home screen is displayed.
3		Back	Return to the previous screen or option.
4		Home	This button will indicate you to go back to central Home screen at any time.
5		Recent Applications	Touch this button to show you a list of images about the applications you have accessed recently. You can touch the listed image to open the applications.
6		Screenshot	Tap this button to capture an image of your screen.
7		Apps	Touch the Apps button to launch all of the applications installed on your device.
8		Bluetooth	The Bluetooth icon will appear on the upper right corner of the screen when you enable the Bluetooth function.
9	4:39	Time	Display the current time.
10		Voice Input	Use voice input as an alternative to text entry via keyboard.
11		Shortcuts	You can add an application shortcut to the Home screen and move it freely by touching and holding the specified icon. This icon allows you to open a shortcut item quickly.

3.4 Navigation buttons



On the bottom of the screen (system bar), you can find the navigation buttons described as below:

Buttons	Descriptions
 Back	<ul style="list-style-type: none"> - Touch this button to go back to the previous screen or option. - If the on-screen keyboard is displayed, the button changes to . Touch it to close the on-screen keyboard.
 Home	<ul style="list-style-type: none"> - Touch this button to go to the central Home screen when viewing other Home screens. - Touch this button to go back to the last Home screen you have viewed when launching any functions on the device. Or touch this button again to go back to central Home screen.
 Recent Apps.	A short-cut way for you to open recent application you have accessed. Select and touch one of the images from the list to open the application directly.
 Screenshot	Tap this button to capture an image of your screen.

3.5 Status Bar



The upper right corner of the screen displays current time, battery status and specified icon (status bar). Touch it and drag down; the status menu will appear as below:

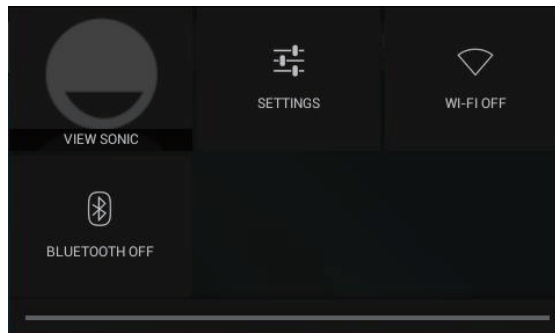

Items	Descriptions
Time	Displays the current time.
Specified Icon	Show you the enabled icon just like enabled Bluetooth.
Status Menu	Show you the current state of your device just like Owner, Brightness, Settings, WIFI, Auto Rotate, Battery Charging Status, Airplane Mode and Bluetooth Settings.

3.5.1 Managing Status Menu

You can touch and drag down the Time area on the status bar to appear the status menu.

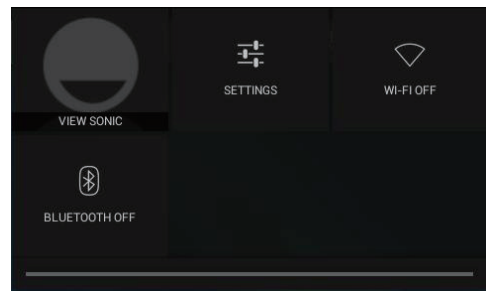

- Touch **OWNER** item to view contact people saved on your system.
- Touch **WIFI** item to enter WIRELESS & NETWORKS configuration menu that allows you to enable/disable and configure Wi-Fi function.
- Touch **CHARGING** item to view the battery charging status. (Not supported for this device)
- Touch **BLUETOOTH** item to enter WIRELESS & NETWORKS configuration menu that allows you to enable/disable and configure Bluetooth function.

Touch any other area of the screen to close the Status Menu.

3.6 Customizing Your Home Screen

3.6.1 Add an Item (Shortcut)

- Touch the Home button to go back the central Home screen.
- Drag on the screen horizontally to select a Home screen where you want to add the item.
- Touch the **Apps** button  located on the bottom of your screen.
- On the **Apps** screen, touch **APPS** or **WIDGETS** tab to enter APPS or WIDGETS configuration screen.
- Select one of **APPS** or **WIDGETS** item that you want to add.
- Touch and hold the item to add it onto the selected Home screen.

3.6.2 Move an Item

- On the Home screen, touch and hold the item that you want to move.
- Move the item to the specified position.
- Then release your finger to add the item to the new position.

3.6.3 Delete an Item

- On the Home screen, touch and hold the item that you want to delete such as a widget or shortcut.
- An “X” will soon be displayed at the top of the Home screen.
- Drag the item over the “X”.
- Then release your finger to delete the item.

3.6.4 Change the Wallpaper

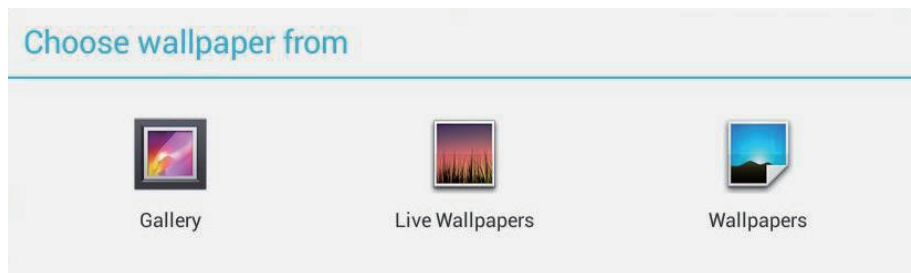

- Long Touch (touch and hold) an empty space on the screen.
- A “**Choose wallpaper from**” configuration screen will appear.
- Select one of the wallpaper sources by touching the specified icon. (Wallpaper sources: Gallery, Live Wallpapers and Wallpapers)
- Tap on the desired wallpaper image. You can always exit by tapping ←↷.
- Once finishing the wallpaper selection, touch “**Set wallpaper**” to renew the wallpaper of Home screen.
- Some wallpaper allows you to change the wallpaper color, ex. Magic Smoke. If “**Settings...**” displays during the changing wallpaper, touch it and on the top of screen, will display “**Tap to change**”, touch the screen to configure the wallpaper color. Tap the screen to cycle through the different colors.
- You can touch **Back** button to go back previous screen without renew any changed settings.

NOTE

- All Home Screens share the same background. You cannot set different wallpapers to individual Home Screen panel.

3.7 Navigating the Applications

You can find applications available on your device in the all Apps menu:

3.7.1 Apps screen

Open the Apps screen

You can access **Apps** screen from any Home screen by touching the **Apps** button 

located on the bottom of your screen. The **Apps** screen contains all of the applications installed on the device including those you have downloaded.

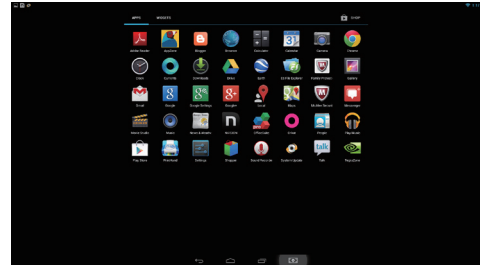

Navigate pages of applications

Flick the **Apps** screen horizontally and touch an application to launch it.

Close the Apps Screen

Touch the Home button on the system bar to go back the central Home screen.

3.7.2 Application Shortcuts

To quickly launch applications on the Home screen, you can add shortcuts for frequently-used application to the Home screen. For more information, please Refer to [3.6 Customizing Your Home Screen](#).



Use the shortcut to open an application

- 1 Touch the Home button on the system bar.
- 2 If the desired application shortcut displays on the Home screen, touch the shortcut to launch the application.

3.7.3 Recent Applications

Open a recently used application

- 1 Touch the Recent Applications button  to view the recently used applications.

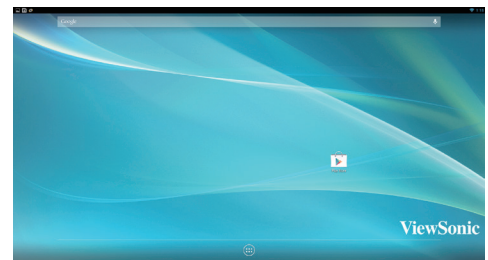

- 2 Scroll the list of recently used applications, and touch the desired application thumbnail to launch the application.
- 3 Touch the Recent Applications button  again to close the list of recently used applications.

3.7.4 Screen Lock Wallpaper

You can set the display to turn off automatically after a timeout period of inactivity, or power it off manually by touching the LED power light. When you touch the LED power light to wake up the display, the screen lock wallpaper appears to avoid unintentional touch of the screen. When the screen lock wallpaper appears, touch and hold the lock icon, drag it to the edge of the larger circle that surrounds it to unlock the screen. Refer to [2.3 Turn On Your Device](#).

NOTE

- Set the duration of screen to remain on before entering sleeping mode, touch the Home button | Apps button | Settings | Display | Sleep.

4 Using Your VSD241 Smart Display

4.1 Managing Contacts

Touch Home button | Apps button | People to view and manage your contacts.

4.1.1 Add a new contact

1 Touch  New.

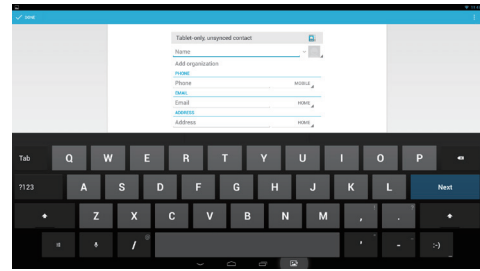

2 Select the account where you want to add this contact, such as your Gmail account.

- This area shows the account in which the new contact is stored.
- Take photo: Touch to take a photo to use as the contact's visual caller ID.
- Select photo from Gallery: Touch to select a photo from the Gallery application to use as the contact's visual caller ID.
- Enter the contact information using the on-screen keyboard. Scroll the screen to find more items to fill.
- Touch to replace a default information label with another label that you can choose from the list. For example, you can change the label from Home phone number to Mobile phone number.
- Touch to add a new item to the current information category. For example, you can add a second phone number.
- Touch to remove an item from the current information category.
- Touch to fill more information about the contact.
- Touch to display more options.
- Touch Cancel to return to your Contacts list.
- Touch **Done** to save the new contact to your Contacts list.
- Touch to return to your Contacts list.

NOTE

- VSD241 supports you fully customized tablet with multiple users. Each person has their own homescreen, background, widgets, apps, games and so on. Multiple users can use one table to talk simultaneously without having to log in and out.

4.1.2 Find a contact

- 1 To locate a contact, you can either:
 - Flick the **All** tab contacts list on the upper left of screen until you find the contact. Or, drag the scroll bar on the left of the screen to scroll through the contacts list.
 - Touch  **Find** contacts on the upper right of screen, and then type either the contact's full name or only the first letters of it into the text box. The screen displays the matching contacts.

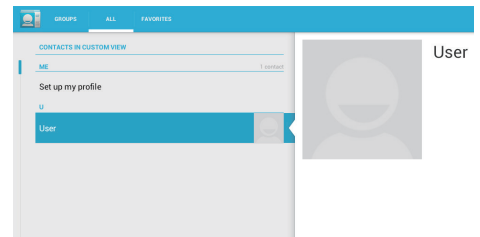

- 2 Once the contact is located, touch the contact's entry to view the contact's details.
-

4.1.3 E-mail or send a message to a contact

- 1 On the contacts list, find a desired contact.
 - 2 Touch the contact entry to view the contact details, and then touch to send e-mail using the e-mail accounts you have set up on your device, or touch it to send a message.
-

Edit a contact

- 1 On the contacts list, find a desired contact.
 - 2 Touch the contact entry to view the contact details.
 - 3 Touch  to edit the contact details.
 - 4 Touch **Done** to save the changes.
-

Share a contact

- 1 On the contacts list, find a desired contact.

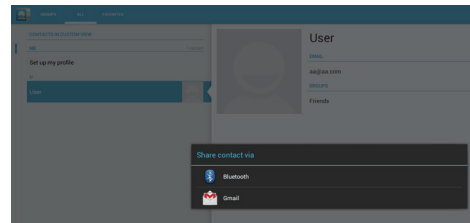

- 2 Touch the contact entry to view the contact details.

- 3 Touch the **Menu** button  on the upper right of screen, then select **Share** contact.

- 4 From the **Share** contact via menu that appears, select the way you want to share the contact information with your friends, such as through Bluetooth or Gmail.
-

NOTE

- Upcoming Gmail App for Android 4.2 brings pinch-to-zoom and swipe to delete. These let you to pinch-to-zoom the Gmail app and swipe to archive/delete the message automatically; you can change the system settings to configure the app for one method or the other.

Join contacts

Since your device can synchronize with a variety of accounts, when synchronizing contacts from these accounts with your device, you may have multiple contacts for the same person. Joining contacts allows you to view all the contact's numbers, addresses, and so on, in one single contact entry.

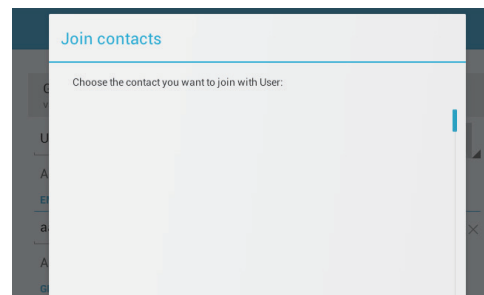

- 1 On the Contacts list, find a desired contact.

- 2 Touch the contact entry to view the contact details, and then touch **Edit**  on the upper right of the screen.

- 3 Then, touch the **Menu** button  on the upper right of the screen | Join.
-

- 4** From the Join contacts list, touch another contact to link, and then touch **Done**. The joined contact's information is displayed with the original **Contacts settings**.

In People, touch the **Menu** button  on the device or the Menu button on the screen.

Settings	Descriptions
<p>Accounts NOTE: If you want to synchronize individual data manually, clear Auto-sync, and then from your account, touch a data item to start synchronization of that data. While data is syncing, the sync icon appears on the option of the data being synced.</p>	<p>Contacts stored on your device can be synchronized with a computer using Mobile Sync; contacts stored on your personal e-mail account such as Gmail can be synchronized through an Internet connection.</p> <ul style="list-style-type: none"> • To select the data to synchronize: <ol style="list-style-type: none"> 1. Select Background data to make all the sync options available. 2. Select Auto-sync to let the device automatically synchronize the selected data in your Twitter account or e-mail account, which may include Twitter contacts and data, or Calendar, Contacts, Gmail, and Picasa Web Albums data. • To select the data to sync from your e-mail account: <ol style="list-style-type: none"> 1. Touch your e-mail account to open the Data & synchronization list. 2. Select the data that you want the device to synchronize automatically, such as Sync Calendar, Sync Contacts, Sync Gmail, Sync Picasa Web Albums.
<p>Import/Export</p>	<p>You can import contacts from your SD card to your device, export Contacts from your device to your SD card, and share visible contacts in multiple ways, such as Bluetooth or Gmail.</p>

4.2 Pop-up Menu

Touch the Menu button on the device or the Menu button on the screen to open or close the pop-up menu that lists available options for the current application, or actions that you can perform on the current screen.

Select an option or item on the pop-up menu

- 1 Touch the Menu button on the device or the Menu button on the screen to open the pop-up menu.
 - 2 Touch the desired item on the pop-up menu.
-

4.3 Google Search

You can use the Google Search widget to find websites and information on Google, applications installed on your device, contacts stored in your Contacts list and sourced from Gmail log in. For Android 4.2 Jelly Bean, Google Now is also made more handy-dandy with the inclusion of cards containing flight information, restaurant reservations, hotel confirmations, and shipping details. You will also find Google Field Trip-esque cards identifying nearby movie times, attractions, photogenic locales, and concerts by your favorite artists.

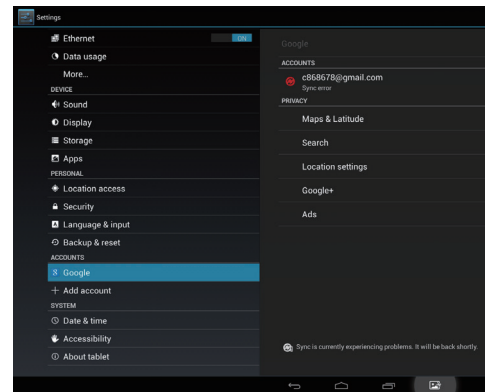

Search by typing

- 1 From the Google Search widget on the Home screen, touch **“Google”** to open the Google Search widget below.
 - 2 Type a keyword or text into the box using the keyboard. As you type, the search results that fully or partially match the text being typed appear.
 - 3 Scroll the listed search results and touch the desired result.
 - 4 The matching application or the browser with matching web links opens.
 - 5 Touch the desired link if you want to view a web page.
-

Search by voice

- 1 Touch the microphone  that appears beside the search box.
- 2 Say the name or keyword of the item you want to search.
- 3 The browser with matching web links opens.

4.4 Managing Your Device Settings

4.4.1 Check storage spaces

Touch the Home button | Apps button | Settings | Storage. The screen displays the total and available space on the device, USB storage and SD card.

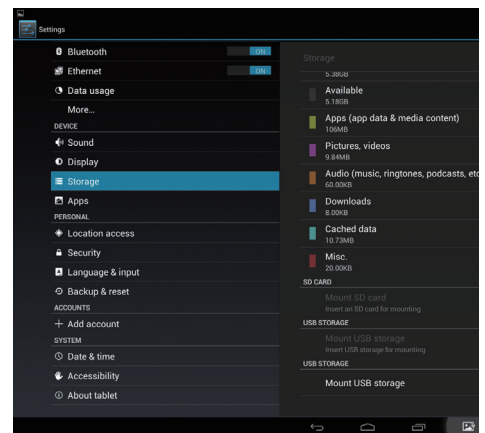

Erase unwanted application data

- 1 Touch the Home button | Apps button | Settings | Apps.

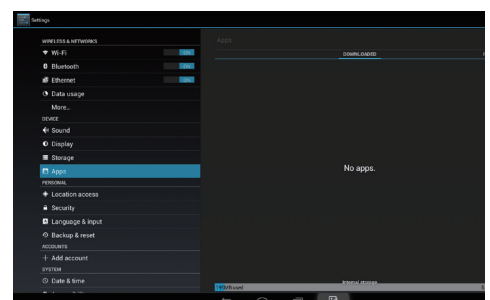

- 2 Touch the application whose cache or data you want to remove.
- 3 Touch **Clear data** under Storage to erase unwanted application data; touch Clear cache under Cache to erase unwanted cache.

4.4.2 Remove the SD card safely

- 1 Touch the Home button | Apps button | Settings | Storage.

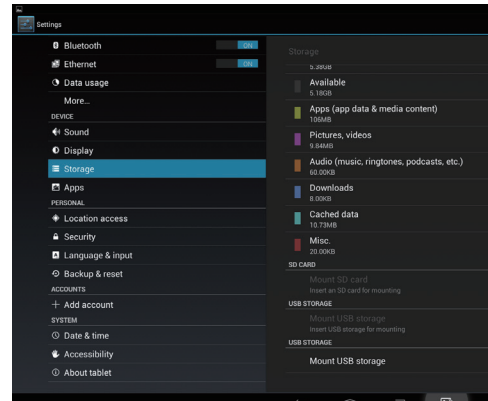

- 2 Touch Unmount SD card under the SD Card section.
- 3 Press and hold the Power button until the Power off menu appears. Then, touch **OK** to turn off the device.
- 4 Pull out the compartment cover and then remove the SD card from your device.

NOTE

- Removing the SD card while the device is working may cause data loss or result in application errors. We suggest you unmount the SD card before removing it.

4.4.3 Erase all data from your device

- 1 Touch the Home button | Apps button | Settings | Backup & reset.

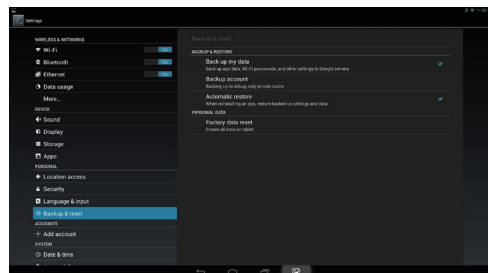

- 2 Touch Factory data reset tablet.
- 3 Touch “**Reset smart display**” to erase everything after you read the warning.

NOTE

- Ensure that you have back up all the required data before erasing all data from your device.

4.5 Connecting to HDMI-compliant Devices via HDMI Input

HDMI (High-Definition Multimedia Interface) is a compact audio/video interface for transferring uncompressed digital audio/video data. You can obtain the best user experience for video playback and gaming via HDMI. VSD241 is equipped with a HDMI input for connection to an external HDMI-compliant device. You can connect your PC, notebook, Blu-ray player or any other HDMI-compliant device to VSD241 for high-definition video display.

How to begin

- 1** A type A (HDMI) to type A (HDMI) HDMI cable must be available.
 - 2** Connect the Type A connector of the HDMI cable to the desired HDMI compliant device.
 - 3** Connect the Type A connector of the HDMI cable to the HDMI port located on the back of your VSD241. Tap the SELECT  icon to switch to Display mode.
 - 4** For PC or notebook connection, always set the appropriate resolution. VSD241 supports with max. resolution of 1920*1080.
 - 5** To enable the Webcam, USB upstream and touch screen function, connect the USB cable to Mini USB connector of VSD241 and connect the other end to your PC or notebook.
-

NOTE

- The touch screen function will work with computers running Windows 7 or later versions without the need for additional drivers.
- When in display mode, the VSD241 Smart Display will temporarily display “No Signal” and then switch back to Android OS when PC enters sleep mode.

4.6 Bluetooth Connection

Bluetooth is a short-range wireless communications technology that allows your device to connect to other Bluetooth-enabled devices over a wireless network. Bluetooth on your device operates in three different modes:

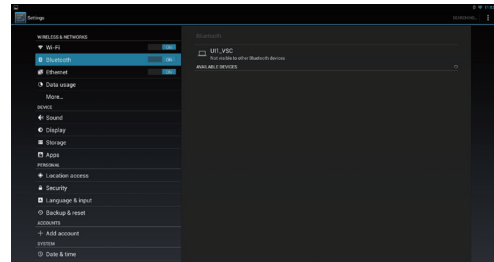

Status	Descriptions
On	Bluetooth is turned on. Your device is enabled to detect Bluetooth devices within range, but will not be found by them.
Discoverable	Bluetooth is turned on, and other Bluetooth devices can detect your device.
Off	Bluetooth is turned off. Your device cannot send and receive data using Bluetooth.

4.6.1 Turn on Bluetooth and make the device discoverable

- 1 Touch the Home button | Apps button | Settings | Bluetooth.
- 2 Enable the Bluetooth function by touching “**ON**” to turn on Bluetooth. The Bluetooth icon appears in the status area of the system bar.

4.6.2 Pair with a Bluetooth device

- 1 Touch the Home button | Apps button | Settings | Bluetooth. Ensure Bluetooth has been enabled on the device you want to pair with, and the device is in Discoverable state.
- 2 Touch **SEARCH FOR DEVICES**. Your device starts to scan for Bluetooth devices within range and then displays all detected devices below the **AVAILABLE DEVICES** list.
- 3 Detect more devices, touch Scan for devices.
- 4 Initiate a connection with a device; touch the name of the device.

- 5 You may be prompted to enter a password to authenticate. Enter the same password on both devices, or enter the password provided by the device manufacturer. Ensure that you read the documentation of the pairing device to check if it requires a default password.
- 6 When the pairing is successful, paired but not connected devices are displayed under the “**PAIRED DEVICE**”.

NOTE

1. The message indicating successful pairing may vary depending on the type of the paired device.
2. Pairing is a one-time process. Once your device successfully pairs with another device, your device recognizes that device without the need to re-enter the password.

4.6.3 Terminate a pairing partnership

- 1 Touch the Home button | Settings | Bluetooth.
- 2 Under the Paired devices section, touch the icon next to a paired device.
- 3 Touch Unpair to erase all pairing information with that device. You need to re-enter the password if you want to restore a Bluetooth connection to that device.

4.6.4 Change your device’s Bluetooth name

- 1 Ensure that you have turned on Bluetooth on your device (Icon in the status area of the system bar indicates that Bluetooth is enabled).

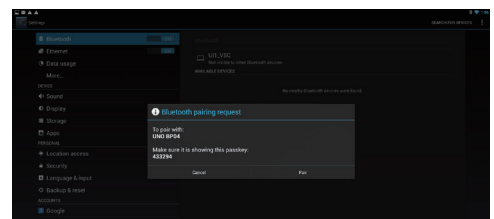

- 2 Touch the Home button | Settings | Bluetooth. Tap the **Menu** button on the upper right-hand side of the screen to rename your smart display.
- 3 Enter a name to identify the device when you connect using Bluetooth.
- 4 Tap **Rename**. Your device’s Bluetooth name has been changed.

5 Internet

5.1 Connecting to the Internet

To browse the web and access web-based utilities such as instant messaging, you can connect VSD241 to a LAN network via RJ45 cable on LAN connector or set up a Wi-Fi connection.

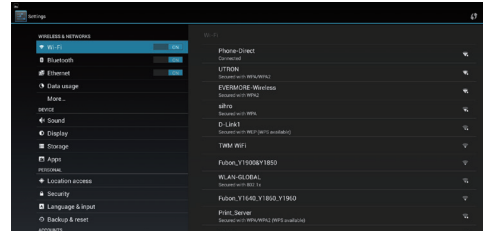

5.1.1 Wi-Fi connection

- 1 Touch the Home button | Apps button | Settings | Wi-Fi to enable Wi-Fi function by touching “ON”. The device scans for available wireless networks.
- 2 Touch Wi-Fi settings. The network names and security settings (Open network or Secured with WEP/WPA/WPA2/WPS) of discovered Wi-Fi networks display in the Wi-Fi networks list.
- 3 Flick the list and touch to select a Wi-Fi network you want to connect to.
- 4 Enter a password (if necessary), then touch Connect to connect to the Wi-Fi network.

Connect to a network protected by Wired Equivalent Privacy (WEP), Wi-Fi Protected Access (WPA), WPA2, or Wireless Protected Setup (WPS), you must enter the WEP/WPA/WPA2/WPS security key to obtain authorized access to the network. The next time your device connects to a previously accessed secured wireless network, you will not be required to enter the WEP/WPA/WPA2/WPS key again, unless you reset your device to its factory default settings.

5.1.2 Check the current Wi-Fi network connection

From the status area of the system bar: When your device is connected to a wireless network, the Wi-Fi icon in the status area of the system bar indicates the signal strength (number of bands that light up). If Settings | Wi-Fi | Network notification is enabled, the “?” icon appears in the notifications area of the system bar, as the device discovers an accessible Wi-Fi network within range.

From the Wi-Fi network:

- 1** Touch the Home button | Apps button | Settings | Wi-Fi.
 - 2** Touch the Wi-Fi network that the device is currently connected to (labeled Connected). A screen opens displaying the Wi-Fi network’s name, status, security information, signal strength, link speed, and IP address.
 - 3** If you want to disconnect the Wi-Fi network from your device, touch Forget on this screen. You will need to configure the Wi-Fi settings again if you want to restore connection to this wireless network.
-

5.1.3 Connect to another Wi-Fi network

- 1** Touch the Home button | Apps button | Settings | Wi-Fi. The detected Wi-Fi networks are displayed in the Wi-Fi networks list.
 - 2** Start a new search for available Wi-Fi networks, on the Wi-Fi settings screen, touch the Menu button  on the upper right of screen | Scan.
 - 3** Flick through the Wi-Fi networks list and touch the name of the network you want to connect to.
 - 4** If the wireless network you want to connect to is not on the list, tap the “+” sign on the upper right-hand side to add your Wi-Fi network. Enter the Wi-Fi network settings, and then touch Save.
-

5.2 Synchronizing Your Google Data

Through a web connection, your device can synchronize your Google data including Gmail, calendar, and contacts with your computer or any other device that you use to access your Google account.

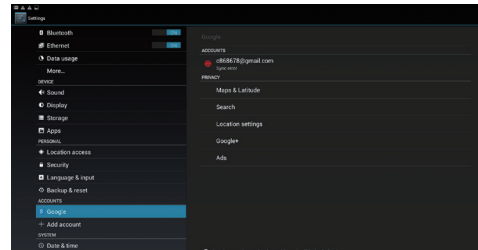

Select the applications to synchronize

- 1 Touch the Home button | Apps button | Settings | ACCOUNTS
- 2 In the ACCOUNTS section, tap the  icon to check the box to enable all the sync options. This includes Sync Calendar, Sync Contacts, Sync Gmail and Sync Picasa Web Albums.
- 3 If you want to add an account to be synchronized, tap on “+ Add Account” on the left of the screen under the account you want to synchronize.

NOTE

- While data is syncing, the sync icon appears on the option of the data being synced.

5.3 Video Chat

Equipping with a front webcam and a microphone, VSD241 allows communication with other users on the Internet. VSD241 supports various video chat apps from Google Play. By default, Google Talk is the most simple video chat application for Android devices and pre-installed already.

Here’s a short list of what you will need to use the video chat function of Google Talk:

- VSD241
- Google Account
- People to chat with (who also have a Google account and have been added into your Google Talk friend list)

How to begin

- 1** **Authenticate your Google account**
You can do this by opening up Google Talk and then signing in to your Google Account. Before using video chat, you must first sign in to your Google Account.

 - 2** **Invite the person**
Open Google Talk application. Locate to the person in your Google Talk friend list who you want to invite to the video chat. Make sure that the friend who you want to chat with is online. Then tap the video button  in the right of your friend's name.

 - 3** **Wait for response**
Now, simply wait for the invited person to join in the video chat. Once your request has been accepted by the invited person, the display will be switched to the video chat window and the chat will begin.
-

NOTE

- If one of sides is not enabling video or voice function, the chat will useless.
-

- 4** **Wait for response**
Now, it is simply to wait the invited person to join, on the other side of the chat, to accept the request. Once the request has been accepted, the video chat window will be changed and you can begin your chat.
-

6 Customizing Your VSD241 Smart Display

You can customize your device using the options available in the Settings application.

6.1 Display Settings

Change the display settings:

- 1 Touch the Home button | Apps button | Settings | Display.
- 2 You can configure the Wallpaper, Sleep, Daydream and Font size here. For Wallpaper, you can also touch and area on the Home screen to open the Wallpaper configuration screen.
- 3 Enable a setting, touch the setting option to select the check box. Disable a setting, touch the setting option to clear the check box.

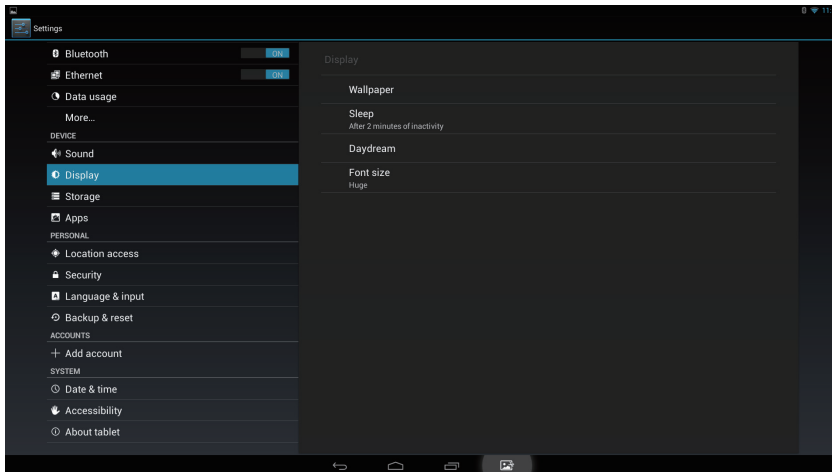

Items	Descriptions
Wallpaper	Refer to 3.6.4 Change the Wallpaper .
Sleep	Here you can configure the idling time for entering power saving mode. (e.g. 15 sec., 30 sec., 1, 2, 5, 10 or 30 min. by default, it is set to 10 minutes.)
Daydream	It activates automatically when the device setup to Daydream to ON (instead of turning the screen off). (e.g. Clock, Colors, Photo Frame, Photo Table)
Font size	Set the Font size to your screen. (Small, Normal, Large or Huge, by default, it is set to Normal)

6.2 Sound and Ringtone Settings

Change the sound and ringtone settings:

- 1 Touch the Home button | Apps button | Settings | Sound.
- 2 Select the list to locate and touch a desired option.
- 3 To enable a setting, touch the setting option to select the checkbox; to disable a setting, touch the setting option to clear the check box.

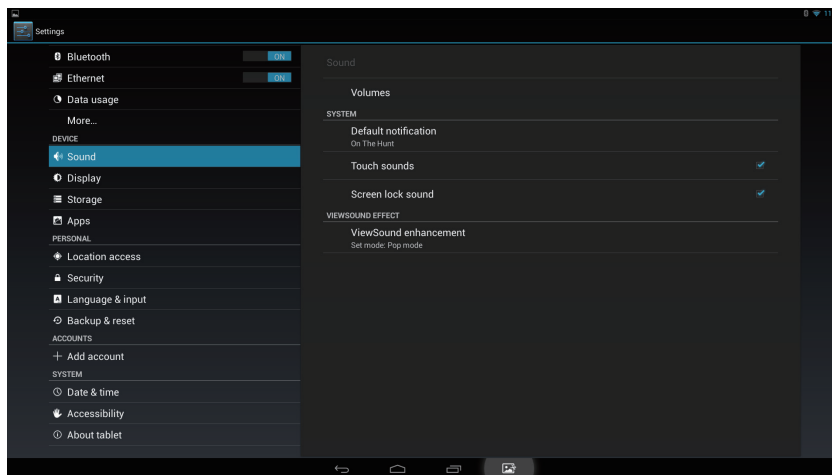

6.2.1 System settings

Items	Descriptions
Touch Sounds	Select this item check box to enable the touch sounds. By default, it is set to enable.
Screen lock sound	Plays a tone when the screen is locked and unlocked. By default, it is set to enable.

6.2.2 Notifications settings

Items	Descriptions
Notification ringtone	<ol style="list-style-type: none"> 1. Select a desired ringtone for notifications from the Ringtones menu that appears. 2. Touch OK to confirm the selection.

NOTE

- You will now receive a warning instead of message by configuring notifications function that may cost you money.

6.2.3 ViewSound enhancement

Items	Descriptions
ViewSound enhancement	1. Set mode with ViewSound effect. 2. Select Pop / Theater / Game / Jazz / Classical or Disable ViewSound effect.

6.3 Date, Time, and Time Zone

New function added:

- 1** The clock has been totally redesigned with an all new look which includes both a digital and analog clock style. You can also resize the digital clock widget to display the time in other cities around the world.

- 2** You can use the new stopwatch to track time, count laps and splits, and share your times.

- 3** You can use the new timer to keep track of predetermined periods of time, run multiple timers at once, and even label your timers.

- 4** The world clock lets you check the time in different cities right from the Clock app or your lock screen.

Manually set the date, time and time zone:

- 1** Touch the Home button | Apps button | Settings | Date & time.

- 2** The related configuration about Date & time will appear on the right section.

- 3** Touch the desired item.

- 4** If you want to automatic date & time, please select the Automatic date & time check box. When this check box is not selected, you can set the date & time by manually.

Items	Descriptions
Automatic date & time	Use network-provide time zone automatically.
Set date	<ol style="list-style-type: none"> 1. Touch Set date item to adjust the day, month, and year; you can also touch the day, month, or year to flick to the desired value. 2. Touch Done to confirm the date.
Set time	<ol style="list-style-type: none"> 1. Touch Set time item to adjust the hour and minute; you can also touch the hour or minute to flick to the desired value. 2. Touch the AM/PM field if the 12-hour format is in use. 3. Touch Done to confirm the time.
Set time zone	Select a city or region that represents the time zone for your device. Touch the Menu button to sort the time zone list alphabetically or by time zone.
Use 24-hour format	Clear this check box to display the time in 12- hour format.
Select date format	Select the format to be used for displaying the date.

6.4 Language & Input Settings

Set the language of the display text:

- 1 Touch the Home button | Apps button | Settings | Language & input | Language. By default, the Language is set to English.
- 2 Select a language of your choice from the list that appears.
- 3 A **Spell checker** function is also supported. Tap the **Spell checker** check box to enable this function.
- 4 For extra defined wording, touch the **Personal dictionary**, then touch **ADD** on the upper right of screen to add new defined wordings to your personal dictionary.

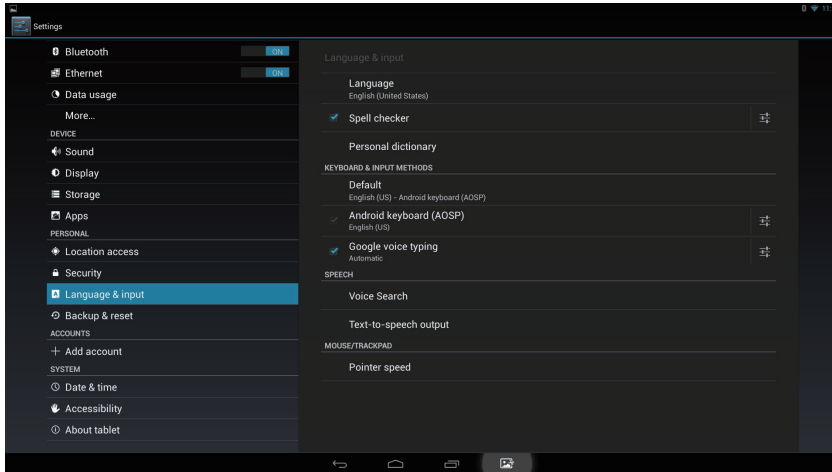

Set the Keyboard & Input:

- 1 Touch the Home button | Apps button | Settings | Language & input | Keyboard & input methods.
- 2 To enable a setting, touch the setting option to select the check box; to disable a setting, touch the setting option to clear the check box.
- 3 You can also touch setting icon for each selection for advanced configurations.

NOTE

- Here you can also configure the speech of voice, test output and pointer.

6.5 OSD Menu



Touch the **Menu/Exit** button on the front panel of your VSD241 to launch OSD configuration screen. The OSD configuration screen can be used to configure the Contrast/Brightness, Input Select, Audio Adjust, Color Adjust, Information, Manual Image Adjust, Setup Menu and Memory Recall.

6.5.1 Adjustment Bars

Contrast/Brightness:

Contrast: Touch and drag the slider on the **Contrast** bar to adjust the contrast of screen display. Drag the slider to the right, the contrast is larger. By default, the contrast is set to 70.

Brightness: Touch and drag the slider on the **Brightness** bar to adjust the brightness of your screen. Drag the slider to the right, the screen is brighter. By default, the brightness is set to 80.

Audio Adjust:

Touch and drag the slider on the **Volume** bar to adjust the volume. Drag the slider to the right, the volume is louder. By default, the volume is set to 50. Here you can also set the volume to Mute or View other sounds.

6.5.2 Functions items

Input Select: Select the input source comes from HDMI or Android. Remember to check the HDMI connection is successful before you select the HDMI item.

Color Adjust: Include sRGB, Bluish, Cool, Native, Warm and user color items.

Information: Select this item to show you the information about your VSD241 including the Resolution, H.Frequency, V.Frequency, Pixel Clock, Model Number, Serial Number and Website.

Manual Image Adjust: Include Sharpness, Dynamic Contrast, Aspect Ratio, Overscan and ECO Mode.

Setup Menu: Include Language Select, Resolution Notice, OSD Position, OSD Time Out, OSD Background, Touch Screen, and Power Indicator.

Memory Recall:

Select the **Memory Recall** function to return the OSD configurations back to factory settings.

NOTE

- OSD language supports English, Deutsch (German), Francais (French), Italian, Spanish, Japanese, Simplified Chinese and Traditional Chinese.

6.5.3 OSD Notice

idling:

The OSD menu will close and go back to the original processing screen automatically during your OSD menu is idling that reached to the OSD time out value.

No signal:

- The connection for your HDMI is not ready.
- The connection between HDMI device and your smart display is not normalization.

7 Protecting Your VSD241 Smart Display

7.1 Protect Your Device Data with a Screen Unlock Pattern

You can protect your device data against unauthorized access by locking the touch screen with a screen unlock pattern. Once the unlock pattern is enabled and the screen is locked, you need to draw the correct unlock pattern to unlock the screen.

After you fail to draw the correct unlock pattern on the screen for five consecutive times, you will be asked to wait for 30 seconds before you can try again. If you no longer remember your screen unlock pattern, follow these steps to unlock your screen:

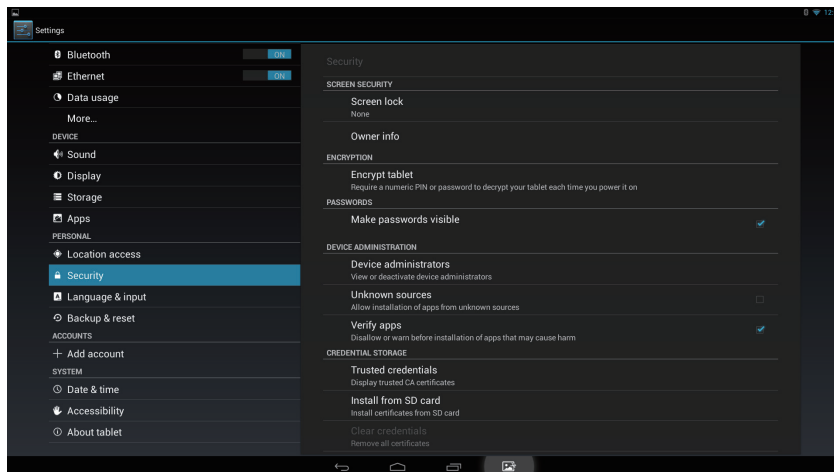

1 Touch **Forgot** pattern.

2 When prompted, sign in to the Google website using your Google account name and password.

3 Draw a new screen unlock pattern.

NOTE

- If you are unable to obtain a new unlock pattern following the above steps.

7.1.1 Create a screen unlock pattern

- 1 Touch the Home button | Apps button | Settings | Security.
 - 2 Touch **Screen Lock** section → **Pattern**.
 - 3 Read the instructions on the screen and study the animated example of how to draw a pattern. Then, touch **Next** when you are ready to draw your own pattern.
 - 4 Drag your finger to draw the unlock pattern by connecting at least four dots in a vertical, horizontal and/or diagonal direction. Take your finger off the screen when a pattern is drawn.
-

NOTE

- You must touch and drag your finger on the screen to create the pattern.
-

- 1 The device records the pattern if it is correctly drawn. Touch **Continue**.
 - 2 Draw the pattern again as prompted, and then touch **Confirm**.
-

NOTE

- If you want to change your unlock screen pattern, you need to draw the old pattern to confirm before creating a new pattern.
-

7.1.2 Change unlock pattern settings

- 1 Touch the Home button | Apps button | Settings | Security.
 - 2 Once the pattern setting is enabled; under the **Screen lock**, Unselect **Make pattern visible** check box if you do not want the lines of the unlock pattern to display on the screen when you draw it.
-

7.2 Disable the screen unlock security

- 1 Touch the Home button | Apps button | Settings | Security.
 - 2 Select **None** to disable screen unlock security.
-

7.3 Protect Your Device Data with a PIN

- 1 Touch the Home button | Apps button | Settings | Security.
 - 2 Touch **Screen Lock** section → **PIN**.
 - 3 On the Choose your PIN screen appears, enter a PIN in the textbox. Your PIN must be 4 characters at least.
 - 4 Touch **Continue** to proceed.
 - 5 Enter the PIN again to confirm.
 - 6 Touch **OK**.
-

7.3.1 Disable or change PIN

- 1 Touch the Home button | Apps button | Settings | Security.
 - 2 Touch **Screen Lock** section.
 - 3 Enter the PIN code you have configured, and then touch **Continue**.
 - 4 Select **None** secured to disable the PIN; select **PIN** to change PIN code.
-

7.4 Protect Your Device Data with a Password

- 1 Touch the Home button | Apps button | Settings | Security.
 - 2 Touch **Screen Lock** section → **Password**.
 - 3 On the Choose your password screen appears, enter a password in the text box. A valid password consists of at least 4 characters and contains at least one letter.
 - 4 Touch **Continue** to proceed.
 - 5 Enter the password again to confirm.
 - 6 Touch **OK**.
-

7.4.1 Disable or change the password

- 1 Touch the Home button | Apps button | Settings | Security.
 - 2 Touch **Screen Lock** section.
 - 3 Enter the **password** you have configured.
 - 4 Select **None** secured to disable the password; select **Password** to change the password.
-

NOTE

- Once the screen lock is secured with Pattern, FaceUnlock, Pin and Password, the **Automatically lock** will appear under **Screen lock**. By default, it is set to 5 seconds after entering sleeping mode.

7.5 Protect Your Device Data with Face Unlock

From Android 4.0 Ice Cream Sandwich, Google had been introduced a new way to unlock your devices via front camera. The facial recognition unlock feature called Face Unlock will be an integral part of Android OS. Follow the steps to get the Face Unlock feature set up on your device:

-
- 1** Touch the **Home** button | **Apps** button | **Settings** | **Security**.

 - 2** Touch **Screen Lock** section → **Face Unlock**.

 - 3** On the right half of the display, it will tell you that Face Unlock is not s secure as other unlock options. Ensure that you have read all the warning messages and then select **Set it up**.

 - 4** You'll now be taken to a screen that gives you some hints on how to setup the photo of your face that will act as the unlocking mechanism on your device. Take heed and select **Continue**.

 - 5** You will then see your face by courtesy of VSD241's front camera. Move a little away from the front camera so your face fits in the Show Your Face screen. Center your face in the outlined area. You will receive a Face Captured screen if the Face Unlock setup was successful and then select **Continue**.

 - 6** Once the Face Unlock is set to your face, you will be prompted to now set up a backup lock. In case the device does not recognize you (this can happen for a bunch of reasons) it will revert to another method for secure unlocking of the phone. Choose one of the two backup methods listed; Pattern or PIN. For a Pattern unlock, slide your finger to connect at least four dots in any pattern of your choosing. Repeat the pattern to confirm the choice. For a PIN unlock, simply input a four digit PIN and repeat to confirm.

 - 7** Touch **OK** to finish the setup.
-

7.6 Power Saving Feature

In order to save energy, this device supports power saving mode (sleeping mode). The device will enter power saving mode when you idle without processing. Then, the screen will go off. You can set the duration of screen to remain on before entering sleeping mode, touch the **Home** button | **Apps** button | **Settings** | **Display** | **Sleep**.

7.7 Power Management Information

Please turn of the device when it will not be used for long time. This could potentially increase the life and decrease the power consumption of the device.

	LED Status
Power On	Blue
Power Standby	Orange
Power OFF	LED OFF

Power On – In off mode, touch the LED power light 0.5 seconds to enter power on mode.

Power Standby – In power on mode, touch the LED power light 0.5 seconds to enter standby mode.

Power Off – In power on mode, touch the LED power light more than 1-2 seconds and select “**OK**” in the dialog box to enter off mode

8 Troubleshooting

8.1 Touch Screen Problems

Problems	Causes	Solutions
Touch screen does not respond to hand gestures or render them properly.	Dust, particles or any foreign material on the camera's or reflector's surface may affect image quality and the display's touch function.	<ol style="list-style-type: none"> 1. Remove any dust or particles from the reflector and camera using compressed air. 2. Gently clean the cameras and reflector surface carefully with a soft antistatic brush to avoid scratches. 3. Clean any remaining dust with a clean, dry dust-free cloth.

8.2 Messaging Problems

Problems	Causes	Solutions
Unable to send or receive text messages.	The signal strength is not strong enough.	Try moving to a different location for better signal reception.
Unable to send or receive e-mail.	The Internet connection or the e-mail setting is not configured properly.	Check your network connection, and confirm with your e-mail service provider if your e-mail setting has been configured correctly.
Unable to connect to the network.	You are not within the network's service area.	Check the service area with your service provider.
	Poor signal.	Move to an open space or if you are inside a building move closer to a window.

8.3 Other Problems

Problems	Solutions
No power	Touch the LED power light for at least 1-2 seconds, if the LED does not light blue with the device booting-up then: <ul style="list-style-type: none"> - Ensure that the power adaptor is plugged-in to a suitable power socket - Ensure that the DC connector is fully inserted into the correct socket on the rear of the VSD241 located under the cover - Check the power socket with another device (i.e. table lamp) - If there is still no power then contact ViewSonic support or the Reseller from whom the device was purchased
No display	Check external HDMI device and connections.
Lock-up	Restart by touching LED power light.
App doesn't function	Check with App author.
No network	Check WiFi settings, try Ethernet if available.
No audio	Check volume level setting.

9 Appendix

Specification

LCD Spec.

Size	61cm (23.8")
Resolution	1920x1080
Brightness	250 cd/m ²
Backlight	LED
Thickness	11.2 mm
Touch screen	Optical touch type, with glass

Hardware

Buttons	Power button *1 Control keys *4
Power LED Indicator	Blue (on) / Orange (saving)
I/O ports	HDMI *1 USB type A *2, mini *1, micro *1 (OTG) 3.5mm Headphone-out *1 LAN (RJ45, supports 100Mbps only) *1 DC-In Jack *1 Full size SD only *1 Kensington Lock (7.5mm diameter) *1
Camera	2M for front pixel camera
Digital / Analog Mic	Digital *2, w/noise cancellation
Mic location	Left/right side of webcam
Card reader	SD card Ver.3.0 or SD-XC up to 2TB
Speakers	2 Watt *2
Adaptor	Input: 100V~240V Output: DC 19V, 3.4A, 65W
Physical	610mm (W) x 480mm (H) x 75mm (D)
Weight	7.2Kg (Net)

SW

OS	Android 4.2.1 JellyBean
Support multi-language	Y
Driver and user's manual in HDD image	Y
Application	Google GMS and VSC consigned

System

CPU/SoC	nVidia Tegra [®] 33
Speed	1.7GHz
Cores	Quad-core
Graphic	Embedded
Memory	DDR3 1GB, Speed to 800Mbps
Storage	eMMC (NAND), 8G
WLAN/Bluetooth	801.11b/g/n, Bluetooth

Environment

Temperature & Humidity	Operation: 20%~90% @ 35°C Non-condensing Storage: 20%~95% R.H.
Altitude	0~5,000m

Accessories

	Power cord (by region) Power adaptor *1 Quick Start Guide *1 MicroUSB cable MiniUSB cable
--	---

Customer Support

For technical support or product service, see the table below or contact your reseller.

NOTE: You will need the product serial number.

Country/Region	Website	T = Telephone F = FAX	Email
Australia/New Zealand	www.viewsonic.com.au	AUS= 1800 880 818 NZ= 0800 008 822	service@au.viewsonic.com
Canada	www.viewsonic.com	T (Toll-Free)= 1-866-463-4775 T (Toll)= 1-424-233-2533 F= 1-909-468-3757	service.ca@viewsonic.com
Europe	www.viewsoniceurope.com	www.viewsoniceurope.com/uk/support/call-desk/	
Hong Kong	www.hk.viewsonic.com	T= 852 3102 2900	service@hk.viewsonic.com
India	www.in.viewsonic.com	T= 1800 266 0101	service@in.viewsonic.com
Korea	www.kr.viewsonic.com	T= 080 333 2131	service@kr.viewsonic.com
Latin America (Argentina)	www.viewsonic.com/la/	T= 0800-4441185	soporte@viewsonic.com
Latin America (Chile)	www.viewsonic.com/la/	T= 1230-020-7975	soporte@viewsonic.com
Latin America (Columbia)	www.viewsonic.com/la/	T= 01800-9-157235	soporte@viewsonic.com
Latin America (Mexico)	www.viewsonic.com/la/	T= 001-8882328722	soporte@viewsonic.com
Renta y Datos, 29 SUR 721, COL. LA PAZ, 72160 PUEBLA, PUE. Tel: 01.222.891.55.77 CON 10 LINEAS Electroser, Av Reforma No. 403Gx39 y 41, 97000 Mérida, Yucatán. Tel: 01.999.925.19.16 Other places please refer to http://www.viewsonic.com/la/soporte/index.htm#Mexico			
Latin America (Peru)	www.viewsonic.com/la/	T= 0800-54565	soporte@viewsonic.com
Macau	www.hk.viewsonic.com	T= 853 2870 0303	service@hk.viewsonic.com
Middle East	ap.viewsonic.com/me/	Contact your reseller	service@ap.viewsonic.com
Puerto Rico & Virgin Islands	www.viewsonic.com	T= 1-800-688-6688 (English) T= 1-866-379-1304 (Spanish) F= 1-909-468-3757	service.us@viewsonic.com soporte@viewsonic.com
Singapore/Malaysia/ Thailand	www.viewsonic.com.sg	T= 65 6461 6044	service@sg.viewsonic.com
South Africa	ap.viewsonic.com/za/	Contact your reseller	service@ap.viewsonic.com
United States	www.viewsonic.com	T (Toll-Free)= 1-800-688-6688 T (Toll)= 1-424-233-2530 F= 1-909-468-3757	service.us@viewsonic.com

Limited Warranty

ViewSonic® Smart Display

What the warranty covers:

ViewSonic warrants its products to be free from defects in material and workmanship, under normal use, during the warranty period. If a product proves to be defective in material or workmanship during the warranty period, ViewSonic will, at its sole option, repair or replace the product with a like product. Replacement product or parts may include remanufactured or refurbished parts or components. The replacement unit will be covered by the balance of the time remaining on the customer's original limited warranty. ViewSonic provides no warranty for the third-party software included with the product or installed by the customer.

How long the warranty is effective:

ViewSonic Smart Display products are warranted for between 1 and 3 years, depending on your country of purchase, for all parts including the light source and for all labor from the date of the first consumer purchase.

User is responsible for the backup of any data before returning the unit for service.

ViewSonic is not responsible for any data loss.

Who the warranty protects:

This warranty is valid only for the first consumer purchaser.

What the warranty does not cover:

1. Any product on which the serial number has been defaced, modified or removed.
2. Damage, deterioration or malfunction resulting from:
 - a. Accident, misuse, neglect, fire, water, lightning, or other acts of nature, unauthorized product modification, or failure to follow instructions supplied with the product.
 - b. Repair or attempted repair by anyone not authorized by ViewSonic.
 - c. Causes external to the product, such as electric power fluctuations or failure.
 - d. Use of supplies or parts not meeting ViewSonic's specifications.
 - e. Normal wear and tear.
 - f. Any other cause which does not relate to a product defect.
3. Any product exhibiting a condition commonly known as "image burn-in" which results when a static image is displayed on the product for an extended period of time.
4. Removal, installation, insurance, and set-up service charges.

How to get service:

1. For information about receiving service under warranty, contact ViewSonic Customer Support (Please refer to the web site and Customer Support pages). You will need to provide your product's serial number.
2. To obtain warranty service, you will be required to provide (a) the original dated sales slip, (b) your name, (c) your address, (d) a description of the problem, and (e) the serial number of the product.
3. Take or ship the product freight prepaid in the original container to an authorized ViewSonic service center or ViewSonic.
4. For additional information or the name of the nearest ViewSonic service center, contact ViewSonic.

Limitation of implied warranties:

There are no warranties, express or implied, which extend beyond the description contained herein including the implied warranty of merchantability and fitness for a particular purpose.

Exclusion of damages:

ViewSonic's liability is limited to the cost of repair or replacement of the product.

ViewSonic shall not be liable for:

1. Damage to other property caused by any defects in the product, damages based upon inconvenience, loss of use of the product, loss of time, loss of profits, loss of business opportunity, loss of goodwill, interference with business relationships, or other commercial loss, even if advised of the possibility of such damages.
2. Any other damages, whether incidental, consequential or otherwise.
3. Any claim against the customer by any other party.
4. Repair or attempted repair by anyone not authorized by ViewSonic.

OTA update disclaimer:

ViewSonic Corporation assumes no liability for any errors or omissions in the information displayed. This firmware update is intended for ViewSonic® smart display. ViewSonic assumes no liability for data loss or any damages caused as a result of any updates made on any device or damage to or failure of other equipment to which the products are connected, whether incidental, consequential or otherwise. You agree to take full responsibility for all files and data and to maintain all appropriate backup of files and data stored on any device prior to performance of any update. Users shall be responsible for obtaining the necessary rights to access and use any third party content. ViewSonic assumes no liability for the performance, availability and use of third party products and services. Corporate names and trademarks mentioned herein are the property of their respective companies. Copyright © 2013 ViewSonic Corporation. All rights reserved.

Manufacturer's Declaration of Conformity

The ViewSonic brand Product VS15197 (Model name: VSD241) has been designed and manufactured in accordance with the Directive 1999/5/EC of European Parliament and the Council on Radio equipment and Telecommunication Terminal equipment. The product is in conformity with the following standards and/or other normative documents:

1. EMC

Standard	Title	Testing Body	Report No.
EN55022: 2010	Limits and methods of measurement of radio interference characteristics of information technology equipment	Burea Veritas Consumer Products Services(H.K.) Ltd. Taoyuan Branch	CE120605D14A
EN55024:2010	Information Technology Immunity standard		
EN61000-3-2: 2009	Disturbances to residential supply system Part 2 : Harmonics		
EN61000-3-3: 2008	Disturbances in supply systems caused by household appliances and similar electrical equipment. Part 3: Voltage fluctuations Part 1: Common technical requirements		

2. HEALTH & SAFETY

Standard	Title	Testing Body	Report No.
EN60950-1: 2011	Information technology equipment – Safety - Part 1: General requirements	UL-DEMKO	DK-27650-UL
EN50332-1:2000 EN50332-2:2003	Sound system equipment: Headphones and earphones associated with portable audio equipment-Maximum sound pressure level measurement methodology and limit considerations. Part 1: General method for “one package equipment”. Part 2: Matching of set with headphones if either or both are offered separately.	N/A	N/A
EN62311:2008	Assessment of electronic and electrical equipment related to human exposure restrictions for electromagnetic fields (0 Hz - 300 GHz)	N/A	N/A
EN62209-1:2006	Procedure to determine the specific absorption rate (SAR) for hand-held devices used in close proximity to the ear (frequency range of 300 MHz to 3GHz)	N/A	N/A
EN62209-2:2010	Human exposure to radio frequency fields from hand-held and body-mounted wireless communication devices. Human models, instrumentation, and procedures. Procedure to determine the specific absorption rate (SAR) for wireless communication devices used in close proximity to the human body (frequency range of 30MHz to 6GHz)	N/A	N/A

3. SPECTRUM

Standard	Title	Testing Body	Report No.
EN301489-1 V1.8.1 EN301489-17 V2.1.1	Electromagnetic compatibility and Radio spectrum Matters (ERM); Electromagnetic Compatibility (EMC) standard for radio equipment and services. Part 1: Common technical requirements. Part 17: Specific conditions for Wideband data and HIPERLAN equipment. Part 24: Specific conditions for IMT-2000 CDMA Direct Spread(UTRA) for Mobile and portable(UE) radio and ancillary equipment. Part 3: Specific conditions of Short-Range Devices(SRD) operating on frequencies between 9kHz and 40GHz. Part 7: Specific conditions for mobile and portable radio and ancillary equipment of digital cellular radio telecommunications systems(GSM and DCS).	SGS	EC/2012/70005
EN300328 V1.7.1	Electromagnetic compatibility and Radio spectrum Matters (ERM) - Wideband transmission systems - Data transmission equipment operating in the 2,4 GHz ISM band and using wide band modulation techniques - Harmonized EN covering essential requirements under article 3.2 of the R&TTE Directive	SGS	EF/2012/70011
EN301511 V9.0.2 EN301908-2 V4.2.1	Global System for Mobile communication(GSM) Harmonized EN for mobile stations in the GSM900 and GSM1800 bands covering essential requirements of article 3.2 of the R&TTE directive(1999/5/EC) Eletromagnetic compatibility and Radio spetrum Matters(ERM); Base Stations(BS) and User Equipment(UE) for IMT-2000 Third-Generation cellular networks;Part 2: Harmonized standrad for IMT-2000, CDMA Direct Spread(UTRA FDD)(UE) covering essential requirement of article 3.2 of the R&TTE Directive	N/A	N/A
EN301908-1 V4.2.1	Eletromagnetic compatibility and Radio spetrum Matters(ERM); Base Stations(BS) and User Equipment(UE) for IMT-2000 Third-Generation cellular networks;Part 1: Harmonized EN for IMT-2000 introduction and common requirements, covering the essential requirements of article 3.2 of the R&TTE Directive	N/A	N/A
EN300440-1 V1.6.1 EN300440-2 V1.4.1	Electromagnetic compatibility and Radio spectrum Matters(ERM);Short range devices;Radop equipment to be used in the 1GHz to 40GHz frequency range;Part 1: Technical characteristics and test methods. Part 2:Harmonized EN covering essential requirements of article 3.2 of the R&TTE Directive	N/A	N/A

3. ErP Directive : 2009/125/EC

Standard	Title	Testing Body	Report No.
(EC) 1275/2008	Eco-design requirements for standby and off mode electric power consumption of electrical and electronic household and office equipment	Quanta Computer	N/A
(EC) 278/2009	Eco-design requirements for no-load condition electric power consumption and average active efficiency of external power suppliers	Delta Electronics Inc.	N/A

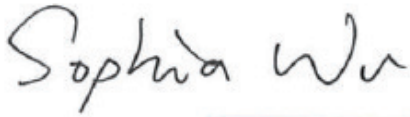

Sophia Wu, Compliance Manager
ViewSonic Corporation

August 23, 2012
Date



ViewSonic®